

GNSS

Global Navigation Satellite System



Model:
GP-170

GNSS

Global Navigation Satellite System

Highly stable and reliable going ships, large yachts,

► Full compliance with IMO Performance Standards and IEC Testing Standards

High performances for Radar, AIS, ECDIS, Autopilot, Eco Sounder, other Sensors for Navigation and Communication Equipment

Function	IMO Perf. Standard	IEC Test Standard
GPS	MSC.112 (73)	IEC61108-1
GLONASS	MSC.113 (73)	IEC61108-2
DGNSS	MSC.114 (73)	IEC61108-4
MULTI (*)	MSC.115 (73)	---
Alert Management	MSC.302 (87)	IEC62923-1/-2

* Combined GPS/GLONASS

► Newly designed GPS chip and antenna unit deliver enhanced stability and precision in position fixing

Enhanced noise rejection capabilities are incorporated in the GPS receiver chip, delivering high level of tolerance towards multi-path mitigation. Also, the tolerance towards multi-path mitigation is enhanced when the antenna unit is used.

► Augmentation to enhance precision by utilizing SBAS (Satellite-Based Augmentation System), DGNSS (Differential Global Navigation Satellite System) and SLAS (Sub-meter Level Augmentation Service)

► 10 Hz position update rate (position updated every 0.1 second) making steady own ship position tracking possible

► USB port available on the front panel

Routing data, menu setting, user setting can be exported/imported through USB jump drives

► Dual configuration for back-up purpose to ensure system availability

Information about waypoints, route and other data set by the operators on one unit can be shared with the other units for functional back-up

► BAM (Bridge Alert Management) ready

Meets the specific requirements for alerts and interconnection with Bridge Alert Management in IMO MSC.302 (87)

► LAN interface for efficient network integration into a bridge system

The GP-170 is fully Light Weight Ethernet (IEC 61162-450) compatible

► Variety of display modes available:

Plotter, Course, Highway, Data and Integrity

A Positioning Display, Icon Display Area.

B Main Display Area. Please refer to each of the display modes for details.

C Action Guidance and Alert Display Area (under alert situation, the information about the most imminent alert is displayed).

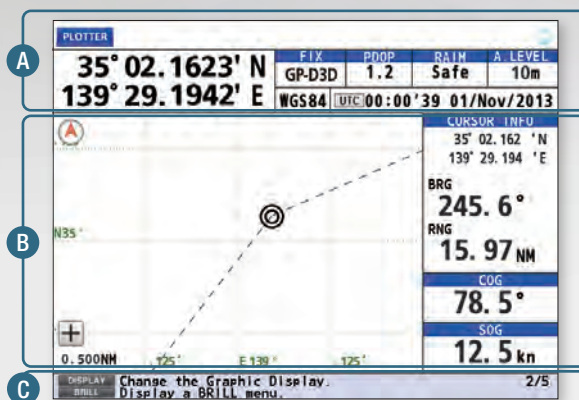

► 5.7" color LCD (with 640 x 480 pixels) for data visualization

► Simplified menu operation

The operator can navigate through the menu tree either by pressing the cursor pad or pressing the corresponding numbers on the numeric keypad to the menu items

► Enhanced route planning/management function available

- Comprehensive range of voyage information to be incorporated in routes
- Streamlined route creation through combination with an external PC (GPX format)
- Sharing the active route information with ECDIS to supplement the ECDIS route monitoring capability

Interconnection Diagram

For new building

*Refer to the Antenna List

**Selectable when beacon receiver is incorporated into the Display Unit GP-170.

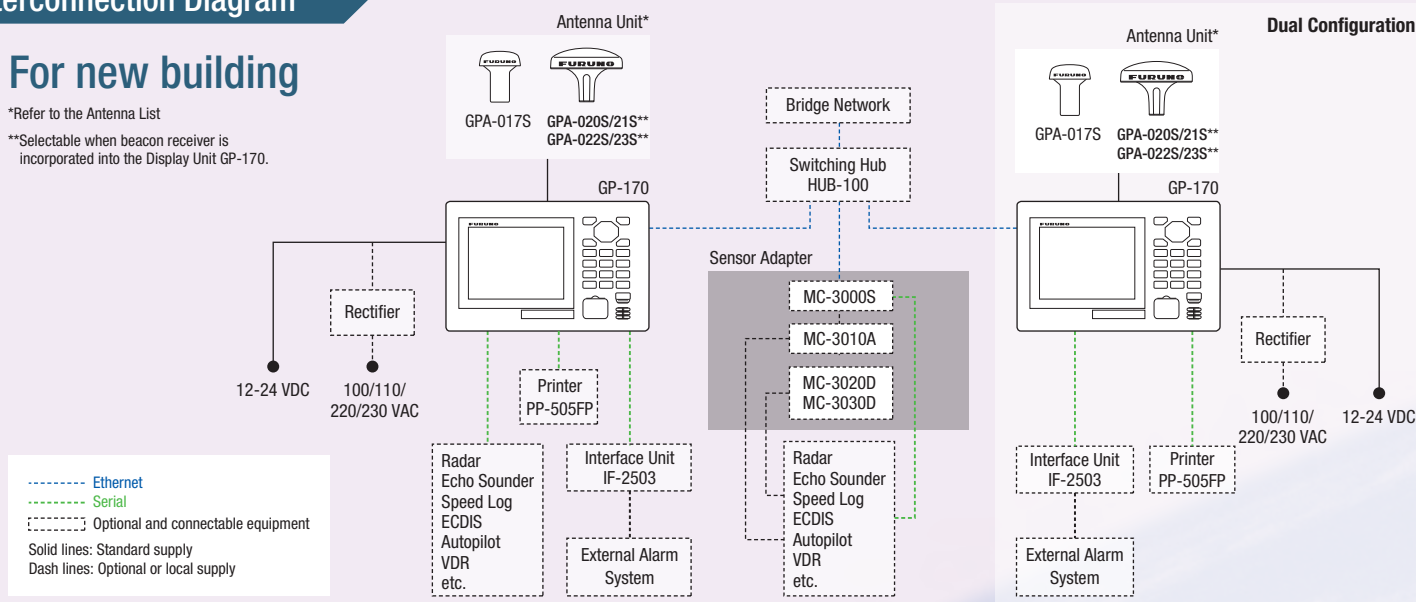

Position fixing system for ocean ferries and commercial vessels



Plotter

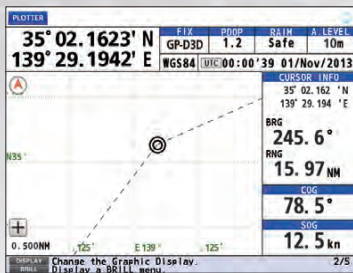

Information to be displayed

- ▶ Simplified plotter display
- ▶ Cursor information
- ▶ Contextual menu
- ▶ SOG/COG data boxes

Integrity

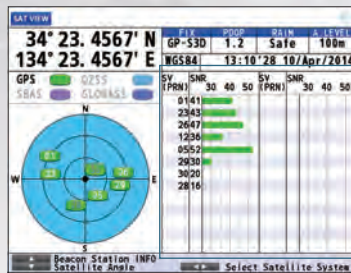

Information to be displayed

- ▶ Skyplot presentation of currently viewable satellites
- ▶ Status on GNSS/SBAS satellite signal reception; including signal strength/signal to noise ratio (in bar/line charts)
- ▶ Elevation angles of the available satellites
- ▶ Detailed information about the beacon stations

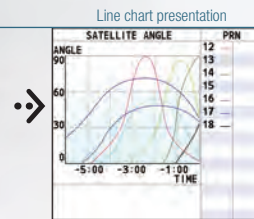

Line chart presentation shows the SNR and satellite angles for the past six hours.

Highway

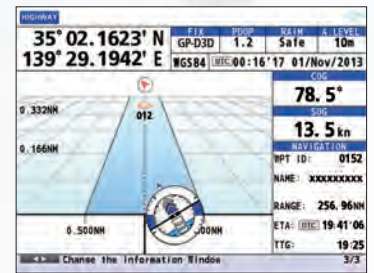

Information to be displayed

- ▶ Course information
- ▶ SOG/COG data boxes
- ▶ User-preset cross track limit of deviation (XTE)
- ▶ Own ship gauge, showing the attitude of the ship, including pitch, roll and heave

Course

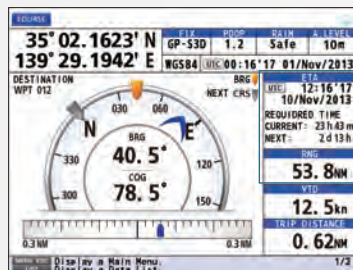

when autopilot is connected

Information to be displayed

- ▶ Graphical presentation of course information, including current waypoint, bearing to the destination, COG, XTE
- ▶ Estimated Time of Arrival data box, including required time to reach the current/next waypoints and range to the waypoint*
*when autopilot is connected, the following information is shown in the data boxes: Autopilot status data box, including mode, ship's heading, rudder angle, and COG, and SOG data box.
- ▶ Velocity to destination
- ▶ Trip distance data

Data

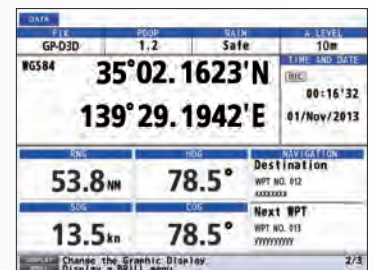

Information to be displayed

- ▶ Navigation data boxes configurable according to the needs of the operators

For retrofitting

* Refer to the Antenna List. The GPA-019S from the GP-150 previously installed can be used. If type-approved DGPS is required, please replace it with GPA-021S.

** Selectable when beacon receiver is incorporated into the Display Unit GP-170.

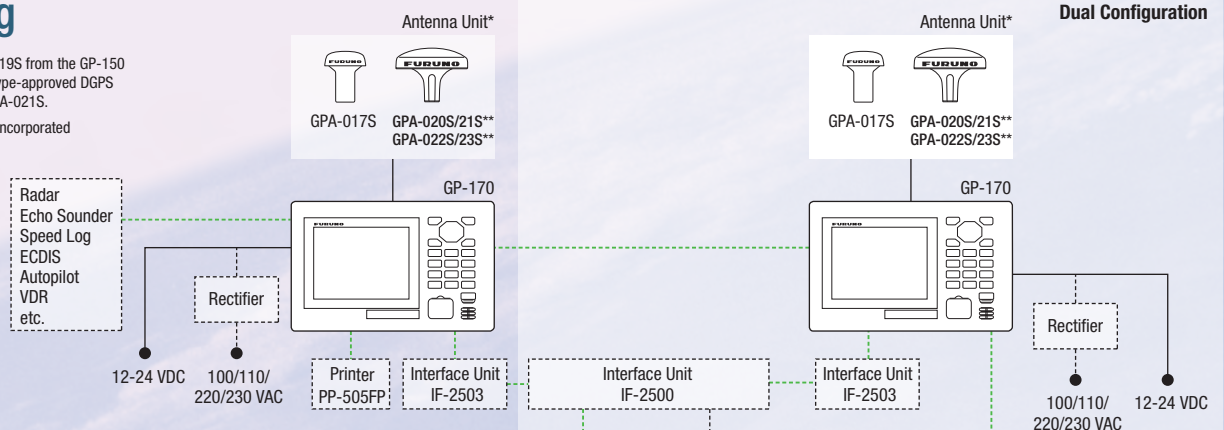

Antenna List

	GPA-017S	GPA-019S	GPA-020S	GPA-021S	GPA-022S	GPA-023S
GPS	○	○	○	○	○	○
OZSS	○	○	○	○	○	○
GLONASS	○	○	○	○	○	○
Multi	○	○	○	○	○	○
DGPS	○	○	○	○	○	○
DGLONASS	○	○	○	○	○	○
SBAS	○	○	○	○	○	○

SPECIFICATIONS

Product Name		GNSS NAVIGATOR
Receiver		
Number of channels	GPS	12 ch
	SBAS	2 ch
	QZSS	4 ch
	GLONASS	10 ch
RX frequency	GPS/SBAS/QZSS	1575.42 MHz ±1.023 MHz
	GLONASS	1602.5625 MHz
Tracking code	GPS	C/A
	SBAS	C/A
	QZSS	C/A, L1S
	GLONASS	L10F
Accuracy*	GPS	not exceeding 10 m (2 drms, HDOP<4)
	DGPS	not exceeding 5 m (2 drms, HDOP<4)
	WAAS	not exceeding 3 m (2 drms, HDOP<4)
	MSAS	not exceeding 7 m (2 drms, HDOP<4)
	QZSS (SLAS) L1S	not exceeding 3 m (2 drms, HDOP<4)
Tracking velocity		1,000 kn
Time to first fix		90 sec when cold start
Position update rate		every 1 sec (standard); every 0.1 sec (max.)* * not available for GLONASS and SLAS modes
Beacon receiver (optional internal kit)	Frequency range	283.5 to 325.0 kHz
	MSK rate	25*, 50, 100, 150, 200 bps * GLONASS only
* Dependent on ionospheric activity and multipath		
Display Unit		
Screen size		5.7" color LCD (116.16 mm x 87.12 mm)
Resolution		640 (H) x 480 (V) pixels (VGA)
Brightness		700 cd/m ²
Display modes		Plotter, Highway, Course, Data, Integrity
Plotter mode	Projection	Mercator
	Memory capacity	1,000 points for ship's track with comments up to 20 characters; 2,000 points for waypoints; 100 routes (containing up to 1,000 waypoints per 1 route)
Integrity mode		GNSS, Graph, Beacon
Alert		Differential positioning interruption, HDOP overshoot, own ship positioning fail, own ship position lost, beacon signal lost, beacon malfunction, antenna short-circuit
Notice		Arrival and anchor watch, XTE, Speed, Trip
Integrity indication		Safe, Unsafe, Caution

Interface

Ports		Serial ports: 2 ports (In/Out), 1 port (Out) IEC 61162-1, 1 port (In/Out) IEC 61162-2; Ethernet: 1 port IEC 61162-450; USB: 1 port (front panel)
Output	Serial	AAM, ALC, ALF, ALR, APA, APB, ARC, BOD, BWC, BWR, BWW, DTM, GBS, GGA*, GLL, GNS, GRS, GSA, GST, GSV, HBT, MSK**, MSS***, POS, QSM, RMB, RMC, Rnn, RTE, VDR, VTG, WCV, WNC, WNR, WPL, XTE, ZDA, RTCM sc104 **when either internal/external beacon receiver is used *** when internal beacon receiver is used
	Ethernet	AAM, ALC, ALF, ALR, APB, ARC, BOD, BWC, BWR, BWW, DTM, GBS, GGA*, GLL, GNS, GRS, GSA, GST, GSV, HBT, POS, QSM, RMB, RMC, RTE, VDR, VTG, WCV, WNC, WPL, XTE, ZDA
Input	Serial	ACK, ACN, CRQ, DBT, DPT, HBT, HDG, HDM, HDT, MSK, MSS, MTW, THS, TLL, VBW, VHW
	Ethernet	ACK, ACN, DBT, DPT, HBT, HDG, HDM, HDT, MTW, THS, TLL, VBW, VHW

* not available when using GLONASS

EQUIPMENT LIST

Standard	1. Display Unit	GP-170	1 unit
	2. Antenna Unit	GPA-017S	1 unit
		GPA-020S	1 unit
		GPA-021S*	1 unit
		GPA-022S	1 unit
		GPA-023S*	1 unit
	* Selectable when a beacon receiver is incorporated into a display unit.		
	3. Antenna Cables	Selectable from 15 m/30 m/40 m/50 m	
4. Installation Materials and Spare Parts			
Option	1. DGPS Receiver Kit	OP20-42	
	2. Antenna Cable	15 m/30 m/40 m/50 m	
	3. Network Cable	3 m with waterproof connector MOD-WPAS0001-030+	
	4. Flush Mount Kit	OP20-40/41	
	5. Antenna Base	NO. 13-QA330	
	6. Interface Unit	IF-2503	
	7. Rectifier	PR-62, PR-240	

ENVIRONMENT

Temperature	Display Unit	-15°C to +55°C
	Antenna Unit	-25°C to +70°C
Relative humidity	95% or less at 40°C	
Degree of protection	Display Unit	IP25
	Antenna Unit	IP56

POWER SUPPLY

12-24 VDC

Display Unit

GP-170
(with an optional flush mount kit)
2.2 kg 4.9 lb (without beacon receiver)
2.4 kg 5.3 lb (with beacon receiver)

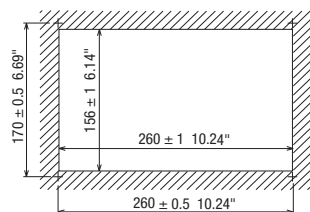
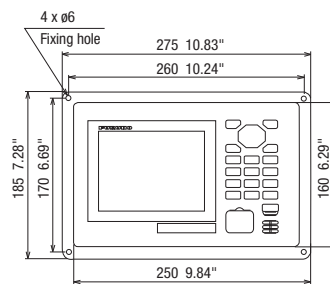
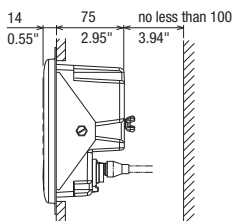

Antenna Unit

GPA-017S (for GPS)
0.12 kg 0.26 lb

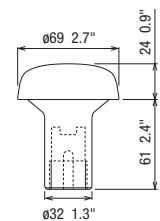

GPA-020S (for GPS)

0.32 kg 0.71 lb

GPA-021S (for DGPS)

0.52 kg 1.15 lb

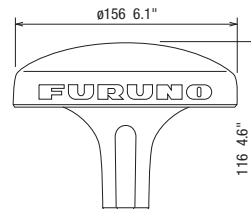

GPA-022S (for GPS+GLONASS)

0.47 kg 1.04 lb

GPA-023S (for DGPS+DGLONASS)

0.65 kg 1.43 lb

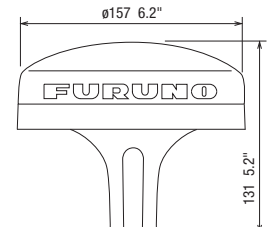

All brand and product names are registered trademarks, trademarks or service marks of their respective holders.
SPECIFICATIONS SUBJECT TO CHANGE WITHOUT NOTICE

FURUNO ELECTRIC CO., LTD.

Japan | www.furuno.com

FURUNO U.S.A., INC.

U.S.A. | www.furunousa.com

FURUNO PANAMA S.A.

Republic of Panama | www.furuno.com.pa

FURUNO (UK) LIMITED

U.K. | www.furuno.co.uk

FURUNO NORGE A/S

Norway | www.furuno.no

FURUNO DANMARK A/S

Denmark | www.furuno.dk

FURUNO SVERIGE AB

Sweden | www.furuno.se

FURUNO FINLAND OY

Finland | www.furuno.fi

FURUNO POLSKA Sp. z o.o.

Poland | www.furuno.pl

FURUNO DEUTSCHLAND GmbH

Germany | www.furuno.de

FURUNO FRANCE S.A.S.

France | www.furuno.fr

FURUNO ESPAÑA S.A.

Spain | www.furuno.es

FURUNO ITALIA S.R.L.

Italy | www.furuno.it

FURUNO HELLAS S.A.

Greece | www.furuno.gr

FURUNO (CYPRUS) LTD

Cyprus | www.furuno.com.cy

FURUNO SHANGHAI CO., LTD.

China | www.furuno.com/cn

FURUNO CHINA CO., LTD.

Hong Kong | www.furuno.com/cn

FURUNO KOREA CO., LTD

Korea

FURUNO SINGAPORE

Singapore | www.furuno.sg

PT FURUNO ELECTRIC INDONESIA

Indonesia | www.furuno.id

FURUNO ELECTRIC (MALAYSIA)

SDN. BHD.

Malaysia | www.furuno.my

G-2305LB

Catalogue No. CA000002149