

FURUNO

SATELLITE COMPASS

Model

SC-70/130

GNSS-powered high accuracy compass



www.furuno.com

High precision and accurate heading of 0.25° (SC-130) Perfect for Radar, ECDIS, AIS, Doppler Sonar and Autopilots



SATELLITE COMPASS

Model **SC-70/130**

Standard High contrast 4.3" Color LCD
(on the screen, the THD mode)
SC-702

The SC-70 and SC-130 are the latest satellite compasses, built on FURUNO's commercial-grade technology platform.

These satellite compasses prove their value by increasing the accuracy of other devices, such as Radar, ARPA, Scanning Sonar, Current Indicator, Chart Plotter, ECDIS and Autopilots.

They provide a highly accurate heading input to these other technologies by utilizing the very latest GNSS (Global Navigation Satellite System). This satellite system is comprised of GPS, Galileo and GLONASS to ensure the highest

precision and a continuous coverage.

The SC-70 and SC-130 provide a variety of data, including GPS Positioning, SOG (Speed Over Ground), COG (Course Over Ground), ROT (Rate Of Turn) and 3-axis speed (bow, stern and longitudinal).

All of these data assist with critical maneuvers, such as berthing.

These compasses are maintenance free and are a great asset for any vessel.

Features

▶ SC-130 features a Tri-sensor antenna that provides a high system accuracy for the heading of your vessel

Provides highly accurate heading data for autopilot, Radar, ARPA, Scanning Sonar, Current Indicator, Chart Plotter, ECDIS and Autopilots.

- **0.25° (with SC-130)**

Ideal for medium to large vessels navigating in crowded ports and making precise maneuvers, such as berthing.

- **0.4° (with SC-70)**

Ideal for small to medium boats requiring highly accurate heading.

▶ Utilizes GNSS such as GPS, Galileo and GLONASS for high-precision attitude

• Eliminating the problem of not having enough satellites at hand by using multiple types of satellites.

▶ Provide precise data for SOG, COG, and L/L

▶ Speed on 3 axis (bow, stern and longitudinal) for safe navigating and berthing

▶ IMO Type-approved as THD, GPS and ROTI. Complying with the IEC, ISO requirements

▶ Easily integrated into the existing shipboard network via Ethernet

▶ Rapid follow-up rate 40°/s (twice the IMO high speed craft requirement, 20°/s)

▶ Maintenance free and no recurring cost as there are no mechanical parts

▶ Super short starting time - 90 seconds

• once the power is on, it takes about 90 seconds to start (the starting time will slightly differ depending on the equipment location)

▶ Easy to retrofit by using existing antenna cabling

• For SC-50/55/60/110/120. (The LAN_CNV option kit is necessary)

▶ Precision pitch/roll data in Analog and Digital formats for vessel stabilization, Sonar, etc.

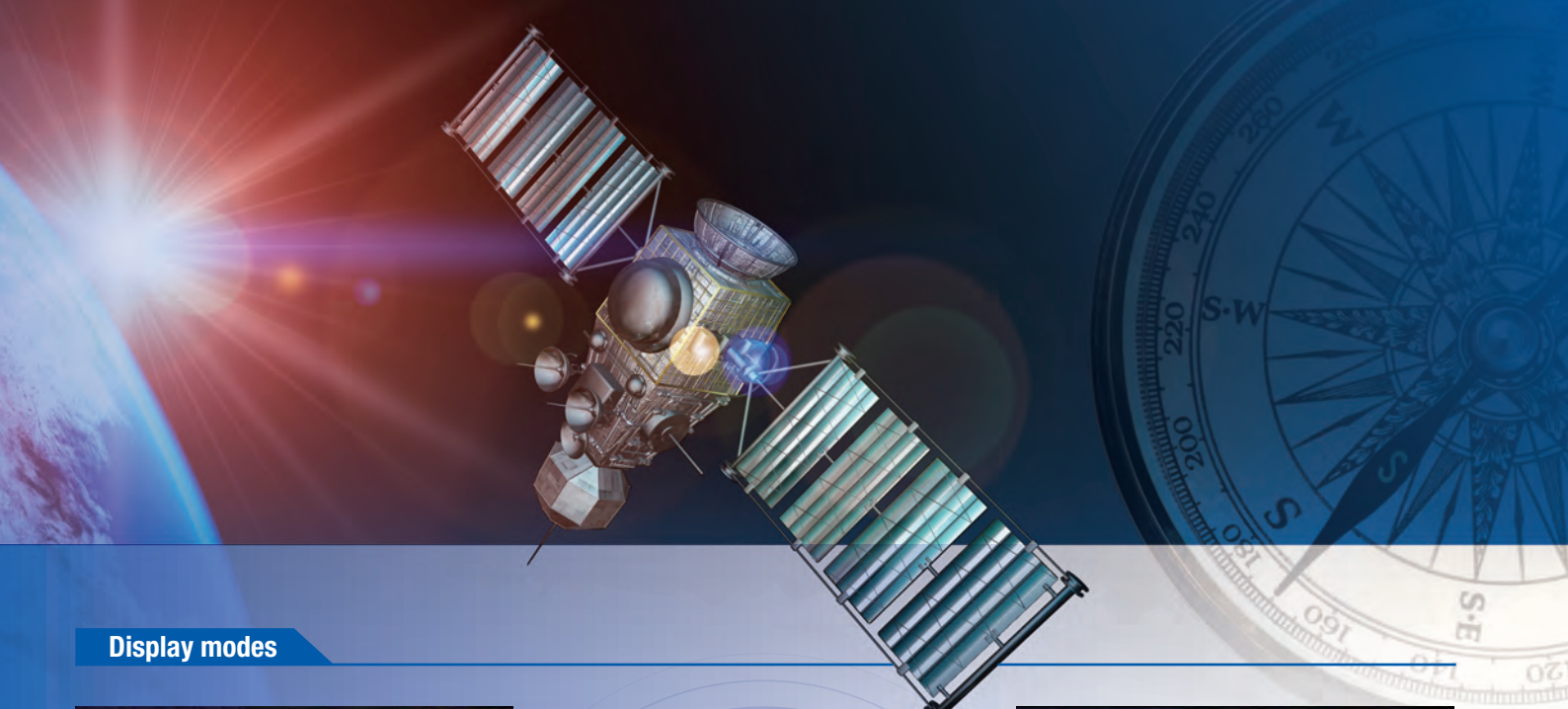

Display modes

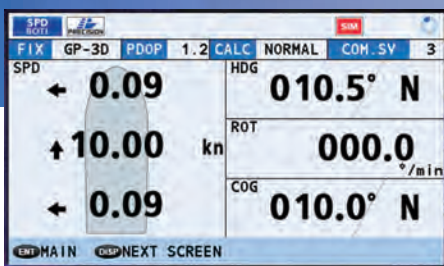

Navigation data screen

- 3-axis speed, as well as the Heading, Rate Of Turn and Course Over Ground can be grasped at a glance. (non-IMO type only)

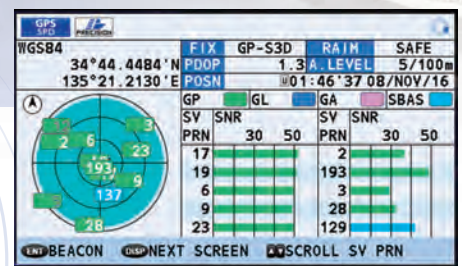

GPS integrity mode

- GPS satellites signal reception including signal strength and signal to noise Ratio
- SBAS signal status

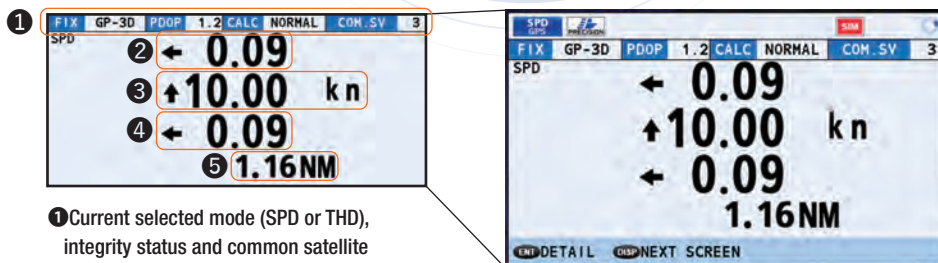

Speed mode

- 3-axis speed of the ship : bow, stern and longitudinal (non-IMO type only)

Interconnection Diagram

- Standard supply
- Optional supply and local supply

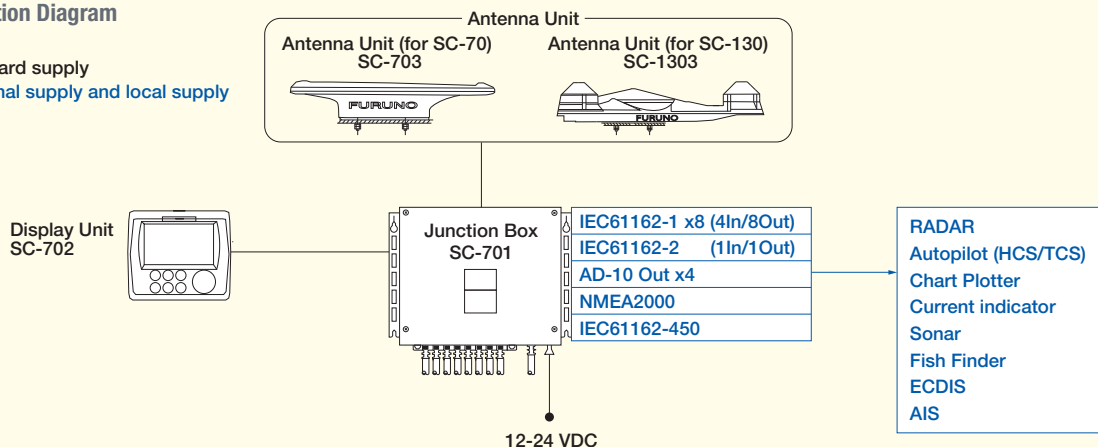

SPECIFICATIONS

GENERAL

Receiving frequency	1575.42 MHz (GPS/Galileo), 1602.5625 MHz (GLONASS), E1B (Galileo), 10F (GLONASS)
Tracking code	C/A code (GPS), E1B (GALILEO), 10F (GLONASS)
Positional accuracy (dependent on ionospheric activity and multipath)	GPS 10 m approx. (2DRMS, HDOP<4) DGPS 5 m approx. (2DRMS, HDOP<4) WAAS 3 m approx. (2DRMS, HDOP<4) MSAS 7 m approx. (2DRMS, HDOP<4)
Ship's speed accuracy (SOG)	0.02 kn RMS (tracking satellites 5 or more)
Ship's speed accuracy (VBW, speed on ground)	0.2% of ship's speed or 0.02 kn whichever is the greater (tracking satellites 5 or more, at antenna position)
Course accuracy	SC-130 0.25° RMS, SC-70 0.4° RMS
Course resolution	0.1°, 0.01°, 0.001° (select from menu)
Attitude resolution	0.1°, 0.01°, 0.001° (select from menu)
Rate of turn	0.1°/s, 0.01°/s or 0.001°/s (select from menu)
Tracking bearing	40°/s
Position fixing time	90 s approx. (typical)
Attitude accuracy	Pitch/ Roll: 0.4° RMS

DISPLAY UNIT

Screen	4.3-inch color LCD, 95.04 mm (W) x 87.12 mm (H)
Resolution	480 x 272 dots (WQVGA)
Brilliance	600 cd/m ² typical
Contrast	17 levels
Display mode	Heading, Nav data, Steering, Compass rose, Rate of turn and Speed modes (Non-IMO types only)

INTERFACE (JUNCTION BOX)

Number of ports (junction box)	
IEC61162-2:	1 port (IN: 1, OUT: 1)
IEC61162-1:	8 ports (IN: 4, OUT: 8)
External beacon input (DATA5 port):	RTCM SC-104 V2.3 (RS-485), ITU-R M823
CANbus:	1 port
AD-10:	4 ports, for heading output
RS-485:	1 port, for display unit connection
LAN (IEC61162-450):	Ethernet, 100Base-TX, RJ45 connector

Data sentences

DATA ports	Input	ACK, ACM, ACN, HBT, HDT*1, MSK, MSS, THS, VBW*2, VDR*2
	Output	ALC, ALF, ALR, ARC, DTM, GBS, GGA, GLL, GNS, GRS, GSA, GST, GSV, HBT, HDG*2, HDM*2, HDT*1, HRM*2, MSK, POS, RMC, ROT, THS, VBW*2, VDR*2, VHW*2, VLW*2, VTG, XDR*2, ZDA

NETWORK ports	Input	ACK, ACM, ACN, HBT
	Output	ALC, ALF, ALR, ARC, DTM, GBS, GGA, GLL, GNS, GRS, GSA, GST, GSV, HBT, HDG, HDM, HDT*1, HRM*2, POS, RMC, ROT, THS, VBW*2, VDR*2, VHW*2, VLW*2, VTG, XDR*2, ZDA

Output proprietary sentences PFEC: GPatt, GPive, GPimu, llar, pidat

PGN	Input	059392/904, 060928, 061184, 126208/720/996
	Output	059392/904, 060928, 061184, 065280, 126208/464/720/992/996, 127250/251/252/257/258, 129025/026/029/033/044/291/539/540/545/547, 130310/312/314/316/577/578/822/823/842/843/845/846

IEC61162-450 transmission group

Input	MISC, SATD, NAVD, PROP
	Arbitrary (default: SATD)

Other network function

NTP, HTTP

*1: Not used for new SOLAS vessels.

*2: for Non-IMO types only.

POWER SUPPLY

Junction box	12-24 VDC: 2.1-1.1 A (included Antenna Unit and Display Unit)
--------------	---

ENVIRONMENTAL CONDITIONS

Ambient temperature	Antenna unit: -25°C to +55°C (storage: -25°C to +70°C) Display unit/ Junction box: -15°C to +55°C
Relative humidity	95% or less at +40°C
Degree of protection	Antenna unit IP56 Display unit IP22 (IP35: option) Junction box IP20 (IP22: bulkhead mount)
Vibration	IEC 60945 Ed.4

EQUIPMENT LIST

Standard

1 Antenna Unit	SC-703 x 1
	SC-1303 x 1
2 Display Unit	SC-702 x 1
3 Junction Box	SC-701 x 1
4 Installation Materials	

Optional supply

1 AC/DC Power Supply Unit	PR-240
2 Alarm Monitoring	IF-2503
3 Interface Unit	IF-NMEA SC
4 Remote Display	RD-50
5 Connector (waterproof)	FRU-RJ-PLUG-ASSY
6 Modular Connector	MPS588-C
7 LAN_CNV Kit	OP20-47/48
8 Wi-fi Module	SX-570-FEC
9 Cable Assembly	M12-05BFFM-010/020/060
10 Connector CANbus (Termination resistor)	LTWMC-05BMMT-SL8001
11 Connector CANbus (T-connector)	SS-050505-FMF-TS001

DISPLAY UNIT (HANGER)

SC-702 0.7 kg, 1.5 lb

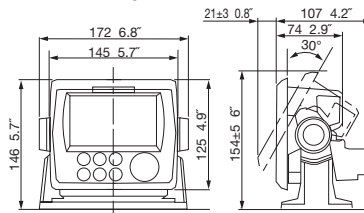

JUNCTION BOX

SC-701 2.9 kg, 6.39 lb

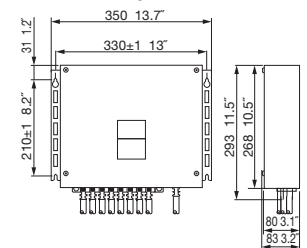

ANTENNA UNIT

SC-1303 7.1 kg, 15.6 lb

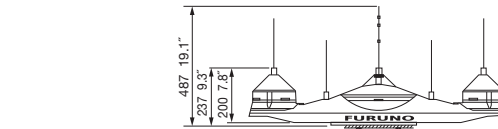
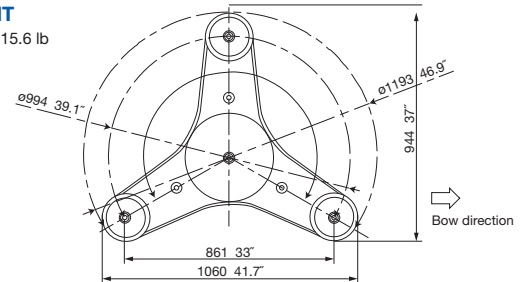

SC-703 2.8 kg, 6.17 lb

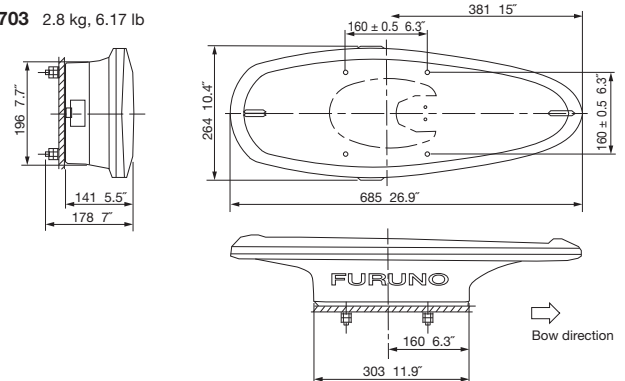

Satellite Compass is a trademark of FURUNO ELECTRIC CO.,LTD

Beware of similar products

All brand and product names are registered trademarks, trademarks or service marks of their respective holders.

SPECIFICATIONS SUBJECT TO CHANGE WITHOUT NOTICE

FURUNO ELECTRIC CO., LTD.
Japan | www.furuno.com

FURUNO U.S.A., INC.
U.S.A. | www.furunousa.com

FURUNO PANAMA S.A.
Republic of Panama | www.furuno.com.pa

FURUNO (UK) LIMITED
U.K. | www.furuno.co.uk

FURUNO NORGE A/S
Norway | www.furuno.no

FURUNO DANMARK A/S
Denmark | www.furuno.dk

FURUNO SVERIGE AB
Sweden | www.furuno.se

FURUNO FINLAND OY
Finland | www.furuno.fi

FURUNO POLSKA Sp. z o.o.
Poland | www.furuno.pl

FURUNO DEUTSCHLAND GmbH
Germany | www.furuno.de

FURUNO FRANCE S.A.S.
France | www.furuno.fr

FURUNO ESPAÑA S.A.
Spain | www.furuno.es

FURUNO ITALIA S.R.L.
Italy | www.furuno.it

FURUNO HELLAS S.A.
Greece | www.furuno.gr

FURUNO (CYPRUS) LTD
Cyprus | www.furuno.com.cy

FURUNO SHANGHAI CO., LTD.
China | www.furuno.com/cn

FURUNO CHINA CO., LTD.
Hong Kong | www.furuno.com/cn

FURUNO KOREA CO., LTD
Korea

FURUNO SINGAPORE
Singapore | www.furuno.sg

PT FURUNO ELECTRIC INDONESIA
Indonesia | www.furuno.id

FURUNO ELECTRIC (MALAYSIA) S.N.D. BHD.

Malaysia | www.furuno.my

D-2406LB

Catalogue No. CA00002384