

DOPPLER SPEED LOG

Model: DS-85

Attain Highly Accurate & Stable Speed Measurement



Highly Accurate Measurements

When a vessel moves through the water, acoustic noise is created and is known as a boundary layer. This noise layer can cause errors with acoustic devices. By measuring speed through water (STW) farther away from the keel, the DS-85 penetrates through this noise and boundary layer resulting in a more stable and accurate speed measurement compared to an electromagnetic speed log.

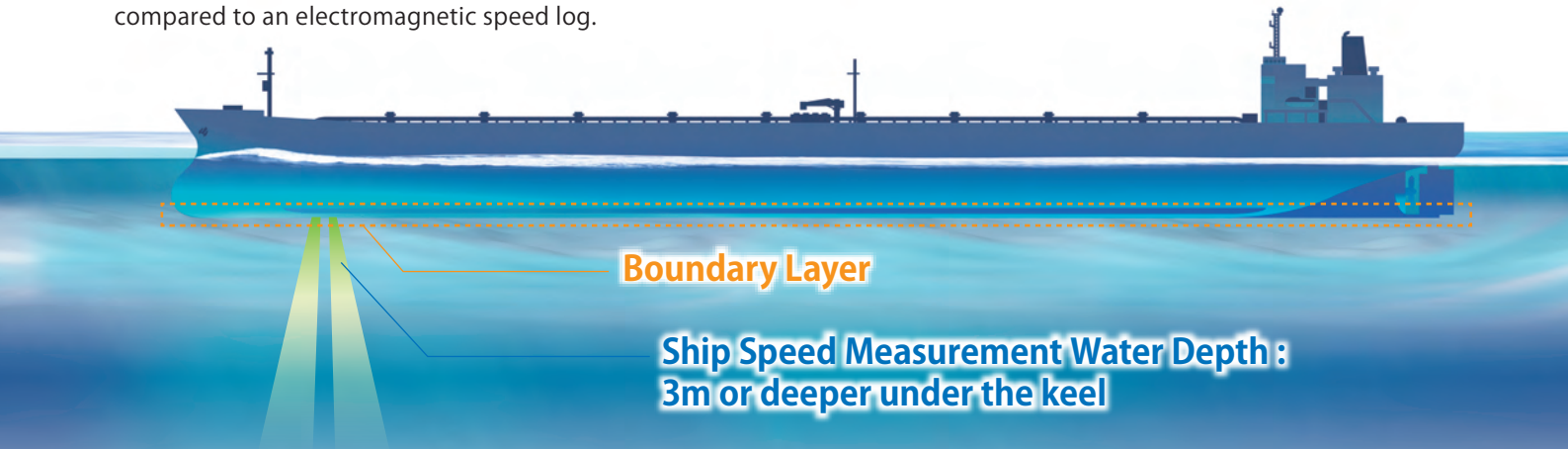

Better Stability

With the new transducer and newly designed process algorithm, the impact of foam is reduced, enabling highly accurate and stable ship speed information.

Compact Gate Valve (Option)

The new compact and lightweight ball-type gate valve is 30% lighter than the traditional valve. When replacing the previous model (DS-80), the same tank or valve can be used, reducing the cost of a retrofit.

Improved Interference Immunity

- ▶ Development of a transducer equipped with the latest technology
 - ① Usage of a high frequency with a strong foam resistance
 - ② Achievement of an optimal ultrasonic width and angle
- ▶ Significant improvement of the signal processing capability

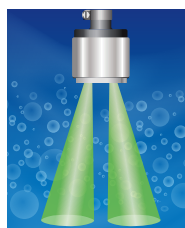

Measurement Image

Comparison between the DS-80 valve (40kg) and the DS-85 valve (27kg)

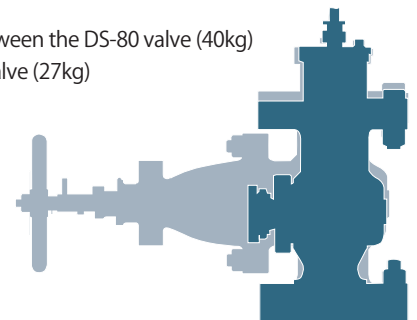

Easy-to-Read Display

Easy-to-read display screen even from a distance, thanks to large characters and clear, bright tones

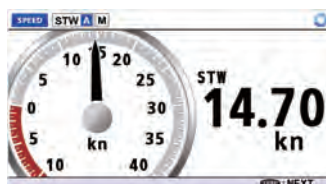

Complies with the latest IMO, IEC Standards

IMO A.694(17)	IEC61023 Ed.3.0
IMO A.824(19)	IEC61162-1 Ed.5.0
IMO MSC.36(63)	IEC61162-2 Ed.1.0
IMO MSC.97(73)	IEC61162-450 Ed.2.0
IMO MSC.191(79)	IEC62288 Ed.2.0
IMO MSC.302(87)	IEC60945 Ed.4.0
	IEC62923-1/-2 Ed.1.0

Specifications

Product Name	Doppler Speed Log			
Number of Transceiver Beams	2 Beams			
Transmission Frequency	2 MHz			
Measurement Speed Range	-40.0 to +40.0kn (Longitudinal Direction)			
Distance Measurement Range	0.00 to 999999.99NM			
Ship Speed Measurable Water Depth	3m or deeper below Ship Bottom			
Output Ship Speed	1-axis to Water Speed			
Ship Speed Measurement Accuracy	±1% or ±0.1kn (larger of the two)			
Distance Measurement Accuracy	±1% or ±0.1NM (larger of the two)			
Power Supply	100-115 VAC:0.6 A / 200-220 VAC:0.4 A			
Display Unit	LCD	4.3 inch Color LDC WQVGA		
	Minimum Brightness	under 0.1 cd/m ²		
	Maximum Brightness	over 600cd/m ²		
	Brightness Adjustment	18 Levels		
	Display Mode	Ship Speed and Distance Screen, Ship Speed Screen, Distance Screen, Analog Meter Screen		
	Display Language	English, Japanese		
	Interface	No. of Ports	Serial Input	2 Ports (IEC 61162-1/2x1, IEC 61162-1x1)
			Serial Output	8 Ports (IEC 61162-1/2x1, IEC 61162-1x7)
			Ethernet	1 Port (IEC 61162-450)
			External KP Input	1 Port
		Sub Display	2 Ports	
		Dimmer	1 Port	
		POWER FAIL Output	1 Port	
		SYSTEM FAIL Output (Option)	1 Port	
		Analog Output (Option)	4 Ports	
		Log Pulse Output (Option)	1 Port	
Environment	Temperature Range	Display Unit		
		Distribution Unit	-15°C to +55°C	
		Transceiver Unit		
	Relative Humidity	Display Unit		
		Distribution Unit	93 % (+40°C)	
	Protection Rating	Display Unit	IP22 (IP35 with Waterproog Kit Installed)	
		Distribution Unit	IP22 (IP20 with Tabletop Mount)	
	Vibration	Transceiver Unit	IP44	
		Transducer	IPX8	
				IEC 60945 Ed.4.0

Dimensions

Display Unit DS-8500

Hanger 0.7 kg 1.5 lb

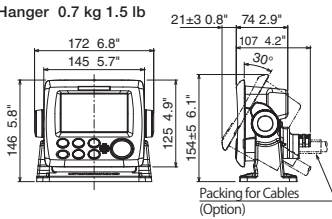

Flushmount (Option) 0.6 kg 1.3 lb

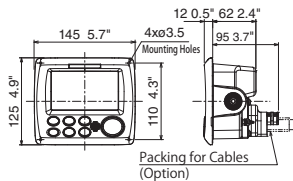

Gate Valve DS-786 40 kg 88.2 lb

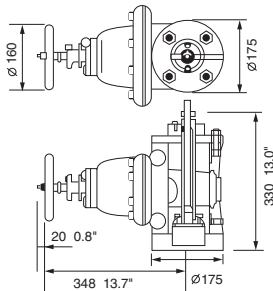

Ball Type Gate Valve DS-854 27 kg 59.5 lb

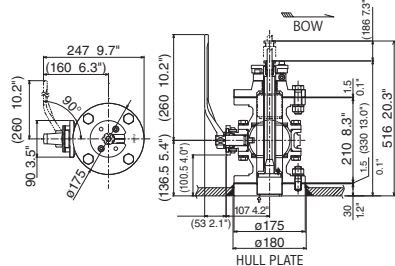

Equipment

Standard

Display Unit	DS-8500	Remote Control Unit	RD-501*
Distribution Unit	DS-8510		* for RD-50/20
	DS-8510-LIF*	Junction Box	CI-630
Transceiver Unit	DS-8520	Ship Bottom Tank : Protrusion Type	DS-781
Transducer	DS-8530	Ship Bottom Tank : Buried Type	DS-784
Installation Material,		Ball Type Gate Valve	DS-854
Accessories, Spares		Gate Valve	DS-786
		LIF Board Kit	OP65-3
		Front Fastening Panel	OP24-35
		F Mount Sponge Kit	OP05-141
		Waterproof Kit	OP05-139
		Replacement Kit	OP05-140
		SC Lock	OP65-4
		Cable Assembly	OP05-146
		Cable Protection Kit	OP05-147
		Installation Material	

Options

Sub Display	DS-8500
	RD-50
	RD-20
Analog Display	SL-200
	FL-200S
Range Switch for Analog Display	DS-389
	MF-22R
Dimmer for Analog Display	DS-F25
	DS-FE25
	DS-S25
	DS-SE25
Dimmer	RD-502

* The Specifications are when the LIF board is mounted. When using the Analog Output, the Log Panel Output or the System Fail, the LIF board is necessary.

Interconnection Diagram

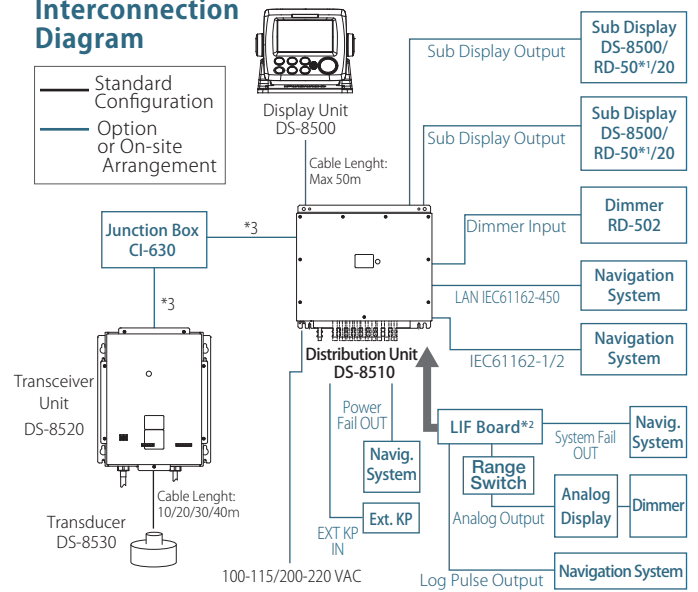

*1 When connecting two RD-50, use the power supply onboard.

The Distribution Box can only supply power to one device.

*2 For the DS-8510-LIF, the LIF board configuration is standard.

*3 The cable length (Distribution Box to Transceiver Box) is up to 400m. If necessary, use the Junction Box.

Transceiver Unit DS-8520 6 kg 13.2 lb

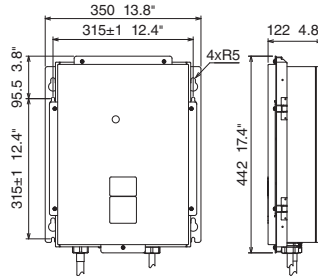

Distribution Unit DS-8510 13 kg 28.7 lb

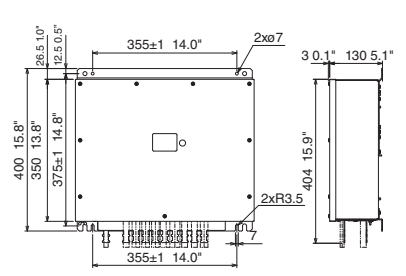

All brand and product names are registered trademarks, trademarks or service marks of their respective holders.
SPECIFICATIONS SUBJECT TO CHANGE WITHOUT NOTICE

FURUNO ELECTRIC CO., LTD.
Japan | www.furuno.com

FURUNO U.S.A., INC.
U.S.A. | www.furunousa.com

FURUNO PANAMA S.A.
Republic of Panama | www.furuno.com.pa

FURUNO (UK) LIMITED
U.K. | www.furuno.co.uk

FURUNO NORGE A/S
Norway | www.furuno.no

FURUNO DANMARK A/S
Denmark | www.furuno.dk

FURUNO SVERIGE AB
Sweden | www.furuno.se

FURUNO FINLAND OY
Finland | www.furuno.fi

FURUNO POLSKA Sp. z o.o.
Poland | www.furuno.pl

FURUNO DEUTSCHLAND GmbH
Germany | www.furuno.de

FURUNO FRANCE S.A.S.
France | www.furuno.fr

FURUNO ESPAÑA S.A.
Spain | www.furuno.es

FURUNO ITALIA S.R.L.
Italy | www.furuno.it

FURUNO HELLAS S.A.
Greece | www.furuno.gr

FURUNO (CYPRUS) LTD
Cyprus | www.furuno.com.cy

FURUNO SHANGHAI CO., LTD.
China | www.furuno.com/cn

FURUNO CHINA CO., LTD.
Hong Kong | www.furuno.com/cn

FURUNO KOREA CO., LTD
Korea

FURUNO SINGAPORE
Singapore | www.furuno.sg

PT FURUNO ELECTRIC INDONESIA
Indonesia | www.furuno.id

FURUNO ELECTRIC (MALAYSIA)
SND. BHD.

Malaysia | www.furuno.my